

14A, 500V, 0.400 Ohm, N-Channel Power MOSFET

This N-Channel enhancement mode silicon gate power field effect transistor is an advanced power MOSFET designed, tested, and guaranteed to withstand a specified level of energy in the breakdown avalanche mode of operation. All of these power MOSFETs are designed for applications such as switching regulators, switching convertors, motor drivers, relay drivers, and drivers for high power bipolar switching transistors requiring high speed and low gate drive power. These types can be operated directly from integrated circuits.

Formerly developmental type TA17435.

Ordering Information

PART NUMBER	PACKAGE	BRAND
IRFP450	TO-247	IRFP450

NOTE: When ordering, use the entire part number.

Features

- 14A, 500V
- $r_{DS(ON)} = 0.400\Omega$
- Single Pulse Avalanche Energy Rated
- SOA is Power Dissipation Limited
- Nanosecond Switching Speeds
- Linear Transfer Characteristics
- High Input Impedance
- Related Literature
 - TB334 "Guidelines for Soldering Surface Mount Components to PC Boards"

Symbol

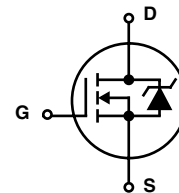

Packaging

JEDEC STYLE TO-247

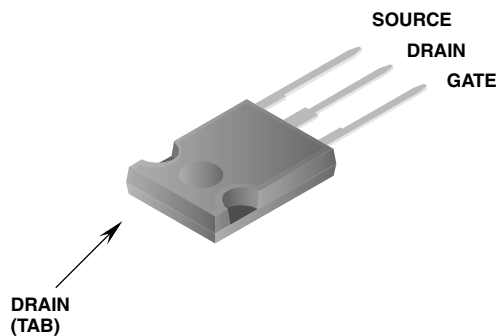

IRFP450

Absolute Maximum Ratings $T_C = 25^\circ\text{C}$, Unless Otherwise Specified

		IRFP450	UNITS
Drain to Source Voltage (Note 1)	V_{DS}	500	V
Drain to Gate Voltage ($R_{GS} = 20k\Omega$) (Note 1)	V_{DGR}	500	V
Continuous Drain Current	I_D	14	A
$T_C = 100^\circ\text{C}$	I_D	8.8	A
Pulsed Drain Current (Note 3)	I_{DM}	56	A
Gate to Source Voltage	V_{GS}	± 20	V
Maximum Power Dissipation	P_D	180	W
Linear Derating Factor		1.44	$\text{W}/^\circ\text{C}$
Single Pulse Avalanche Energy Rating (Note 4)	E_{AS}	860	mJ
Operating and Storage Temperature	T_J, T_{STG}	-55 to 150	$^\circ\text{C}$
Maximum Temperature for Soldering			
Leads at 0.063in (1.6mm) from Case for 10s.	T_L	300	$^\circ\text{C}$
Package Body for 10s, See Techbrief 334	T_{pkg}	260	$^\circ\text{C}$

CAUTION: Stresses above those listed in "Absolute Maximum Ratings" may cause permanent damage to the device. This is a stress only rating and operation of the device at these or any other conditions above those indicated in the operational sections of this specification is not implied.

NOTE:

- $T_J = 25^\circ\text{C}$ to 125°C .

Electrical Specifications $T_C = 25^\circ\text{C}$, Unless Otherwise Specified

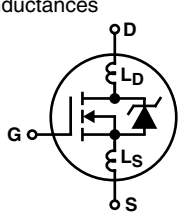
PARAMETER	SYMBOL	TEST CONDITIONS	MIN	TYP	MAX	UNITS	
Drain to Source Breakdown Voltage	BV_{DSS}	$I_D = 250\mu\text{A}, V_{GS} = 0\text{V}$ (Figure 10)	500	-	-	V	
Gate Threshold Voltage	$V_{GS(TH)}$	$V_{GS} = V_{DS}, I_D = 250\mu\text{A}$	2.0	-	4.0	V	
Zero Gate Voltage Drain Current	I_{DSS}	$V_{DS} = \text{Rated } BV_{DSS}, V_{GS} = 0\text{V}$	-	-	25	μA	
		$V_{DS} = 0.8 \times \text{Rated } BV_{DSS}, V_{GS} = 0\text{V}, T_J = 125^\circ\text{C}$	-	-	250	μA	
On-State Drain Current (Note 2)	$I_{D(ON)}$	$V_{DS} > I_{D(ON)} \times r_{DS(ON)MAX}, V_{GS} = 10\text{V}$	14	-	-	A	
Gate to Source Leakage Current	I_{GSS}	$V_{GS} = \pm 20\text{V}$	-	-	± 100	nA	
On Resistance (Note 2)	$r_{DS(ON)}$	$I_D = 7.9\text{A}, V_{GS} = 10\text{V}$ (Figures 8, 9)	-	0.3	0.4	Ω	
Forward Transconductance (Note 2)	g_{fs}	$V_{DS} \geq 50\text{V}, I_D = 7.9\text{A}$ (Figure 12)	9.3	13.8	-	S	
Turn-On Delay Time	$t_{d(ON)}$	$V_{DD} = 250\text{V}, I_D \approx 14\text{A}, V_{GS} = 10\text{V}, R_{GS} = 6.1\Omega, R_L = 17.4\Omega$ MOSFET Switching Times are Essentially Independent of Operating Temperature	-	16	27	ns	
Rise Time	t_r		-	45	66	ns	
Turn-Off Delay Time	$t_{d(OFF)}$		-	68	100	ns	
Fall Time	t_f		-	41	60	ns	
Total Gate Charge (Gate to Source + Gate to Drain)	$Q_{g(TOT)}$	$V_{GS} = 10\text{V}, I_D \approx 14\text{A}, V_{DS} = 0.8 \times \text{Rated } BV_{DSS}$ $I_{G(REF)} = 1.5\text{mA}$ (Figure 14) Gate Charge is Essentially Independent of Operating Temperature	-	82	130	nC	
Gate to Source Charge	Q_{gs}		-	12	-	nC	
Gate to Drain "Miller" Charge	Q_{gd}		-	42	-	nC	
Input Capacitance	C_{ISS}	$V_{DS} = 25\text{V}, V_{GS} = 0\text{V}, f = 1\text{MHz}$ (Figure 11)	-	2000	-	pF	
Output Capacitance	C_{OSS}		-	400	-	pF	
Reverse Transfer Capacitance	C_{RSS}		-	100	-	pF	
Internal Drain Inductance	L_D	Measured from the Contact Screw on Header Closer to Source and Gate Pins to Center of Die	Modified MOSFET Symbol Showing the Internal Device Inductances 	-	5.0	-	nH
Internal Source Inductance	L_S	Measured from the Source Lead, 6.0mm (0.25in) from Header to Source Bonding Pad		-	12.5	-	nH
Thermal Resistance, Junction to Case	$R_{\theta JC}$		-	-	0.70	$^\circ\text{C}/\text{W}$	
Thermal Resistance, Junction to Ambient	$R_{\theta JA}$	Free Air Operation	-	-	30	$^\circ\text{C}/\text{W}$	

IRFP450

Source to Drain Diode Specifications

PARAMETER	SYMBOL	TEST CONDITIONS	MIN	TYP	MAX	UNITS
Continuous Source to Drain Current	I_{SD}	Modified MOSFET Symbol Showing the Integral Reverse P-N Junction Rectifier	-	-	14	A
Pulse Source to Drain Current (Note 3)	I_{SDM}		-	-	56	A
Source to Drain Diode Voltage (Note 2)	V_{SD}	$T_J = 25^\circ\text{C}$, $I_{SD} = 14\text{A}$, $V_{GS} = 0\text{V}$ (Figure 13)	-	-	1.4	V
Reverse Recovery Time	t_{rr}	$T_J = 150^\circ\text{C}$, $I_{SD} = 13\text{A}$, $dI_{SD}/dt = 100\text{A}/\mu\text{s}$	-	1300	-	ns
Reverse Recovery Charge	Q_{RR}	$T_J = 150^\circ\text{C}$, $I_{SD} = 13\text{A}$, $dI_{SD}/dt = 100\text{A}/\mu\text{s}$	-	7.4	-	μC

NOTES:

- Pulse test: pulse width $\leq 300\mu\text{s}$, duty cycle $\leq 2\%$.
- Repetitive rating: pulse width limited by Max junction temperature. See Transient Thermal Impedance curve (Figure 3).
- $V_{DD} = 50\text{V}$, starting $T_J = 25^\circ\text{C}$, $L = 7.9\text{mH}$, $R_G = 25\Omega$, peak $I_{AS} = 14\text{A}$.

Typical Performance Curves Unless Otherwise Specified

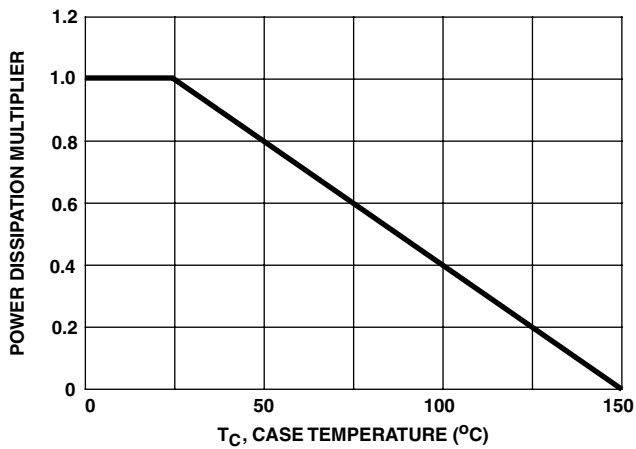

FIGURE 1. NORMALIZED POWER DISSIPATION vs CASE TEMPERATURE

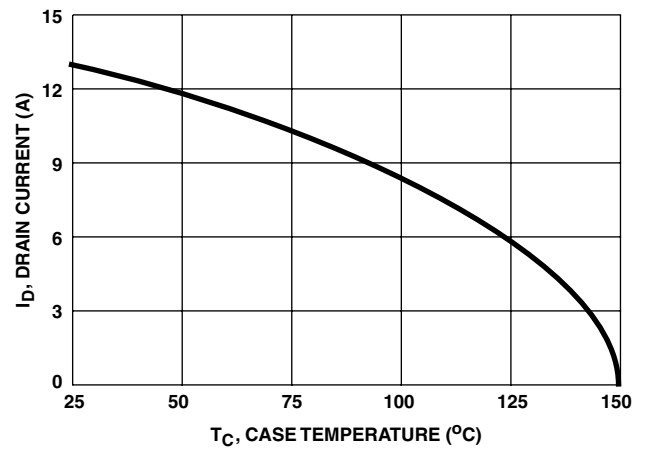

FIGURE 2. MAXIMUM CONTINUOUS DRAIN CURRENT vs CASE TEMPERATURE

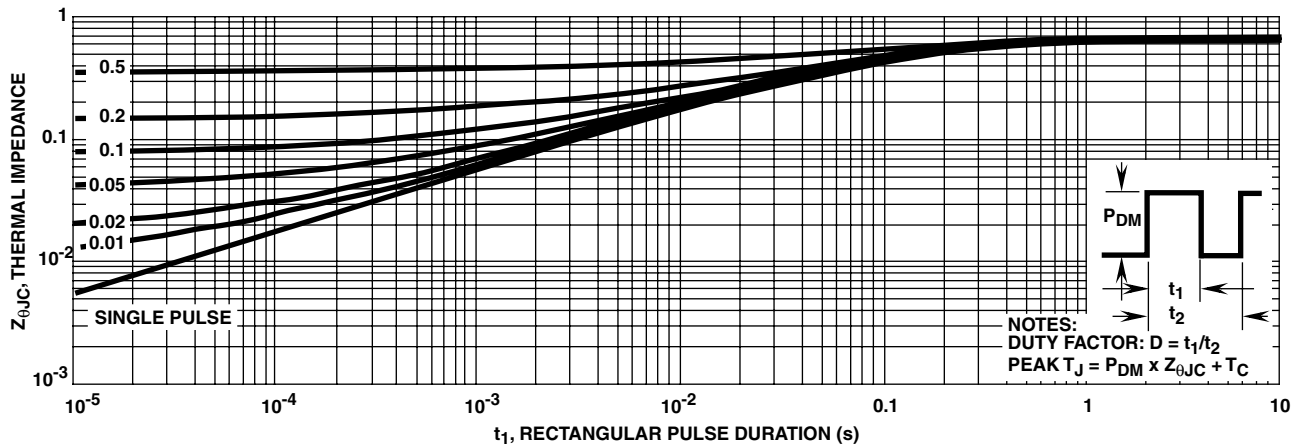

FIGURE 3. MAXIMUM TRANSIENT THERMAL IMPEDANCE

Typical Performance Curves Unless Otherwise Specified (Continued)

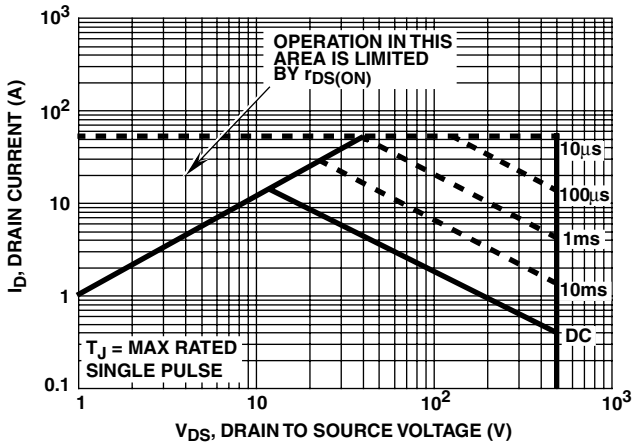

FIGURE 4. FORWARD BIAS SAFE OPERATING AREA

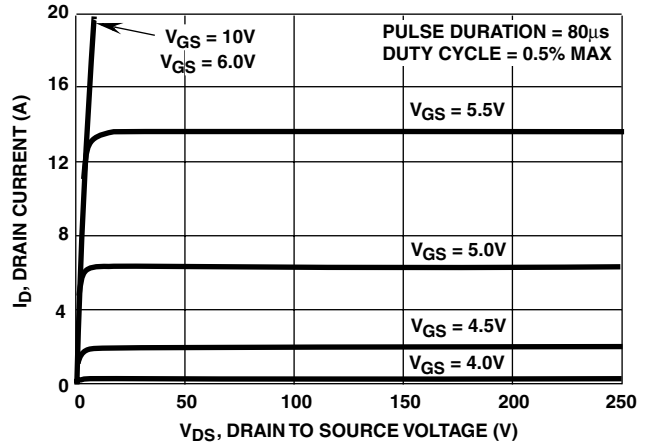

FIGURE 5. OUTPUT CHARACTERISTICS

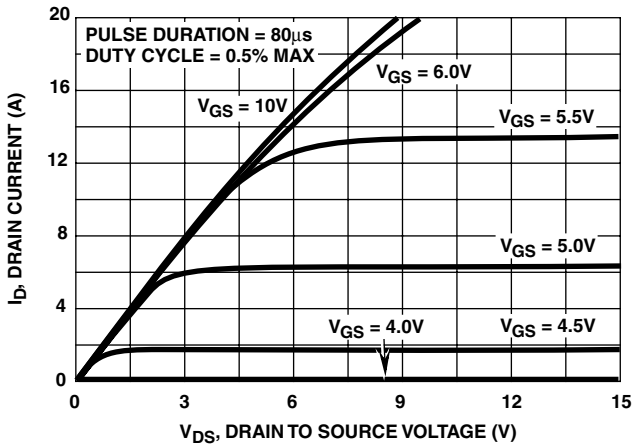

FIGURE 6. SATURATION CHARACTERISTICS

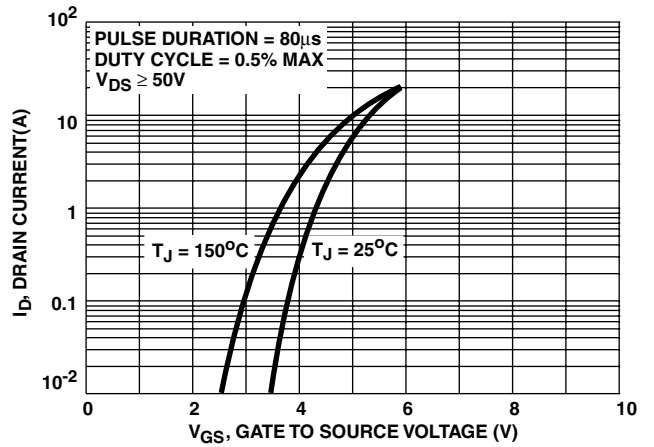
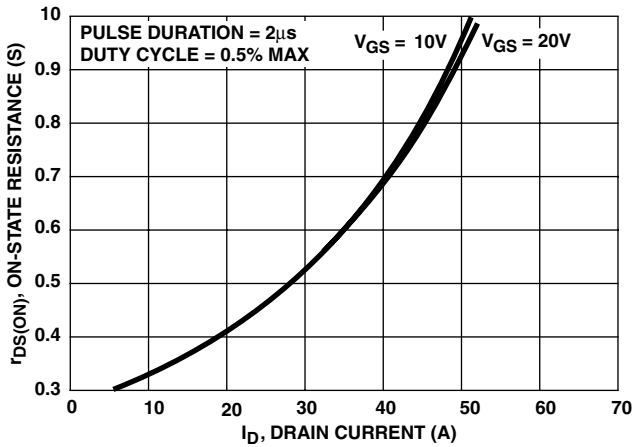

FIGURE 7. TRANSFER CHARACTERISTICS



NOTE: Heating effect of 2µs is minimal.

FIGURE 8. DRAIN TO SOURCE ON RESISTANCE vs GATE VOLTAGE AND DRAIN CURRENT

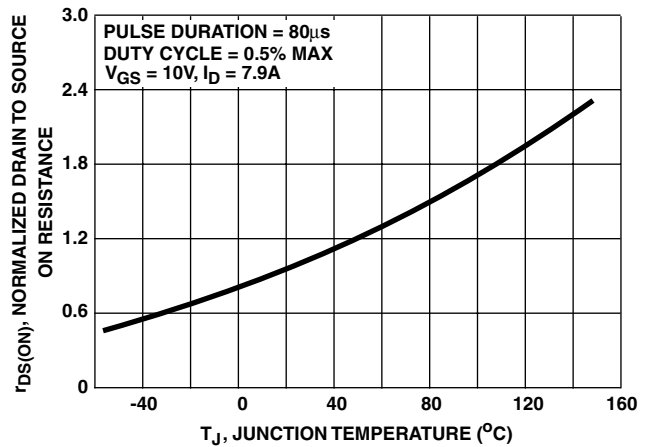

FIGURE 9. NORMALIZED DRAIN TO SOURCE ON RESISTANCE vs JUNCTION TEMPERATURE

Typical Performance Curves Unless Otherwise Specified (Continued)

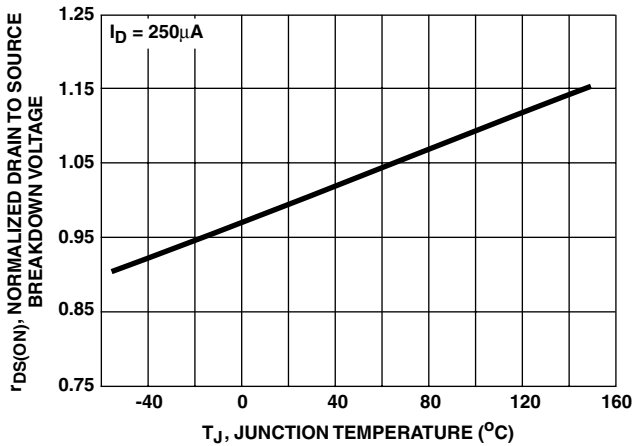

FIGURE 10. NORMALIZED DRAIN TO SOURCE BREAKDOWN VOLTAGE vs JUNCTION TEMPERATURE

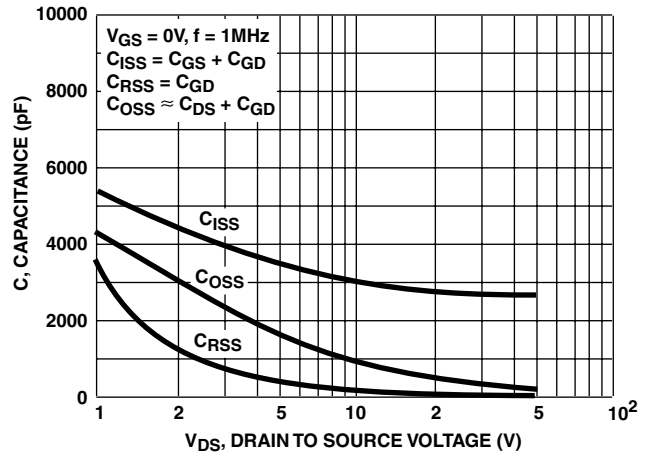

FIGURE 11. CAPACITANCE vs DRAIN TO SOURCE VOLTAGE

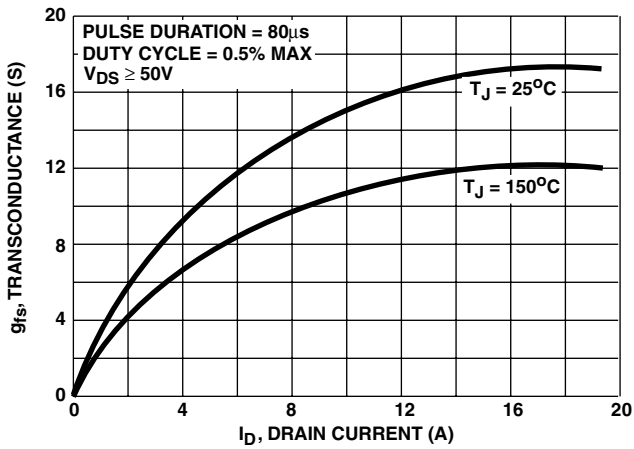

FIGURE 12. TRANSCONDUCTANCE vs DRAIN CURRENT

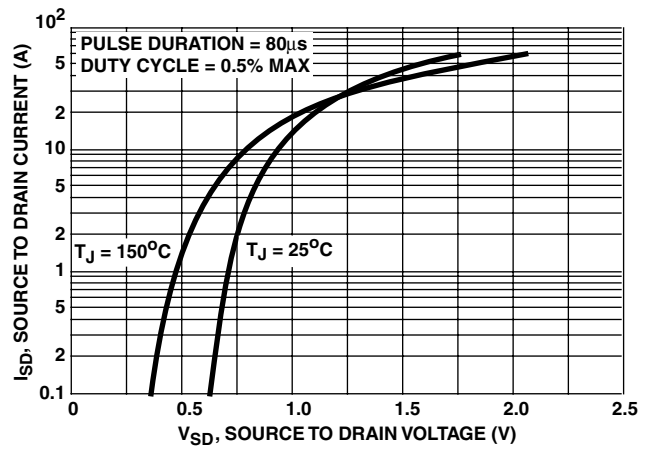

FIGURE 13. SOURCE TO DRAIN DIODE VOLTAGE

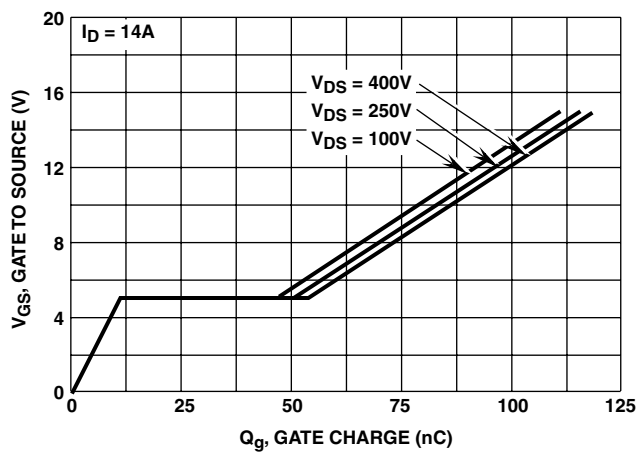

FIGURE 14. GATE TO SOURCE VOLTAGE vs GATE CHARGE

Test Circuits and Waveforms

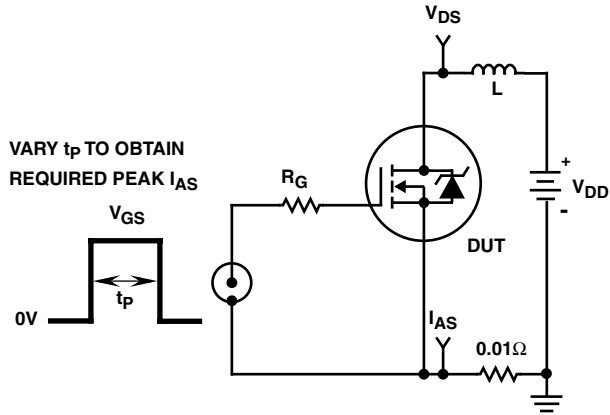

FIGURE 15. UNCLAMPED ENERGY TEST CIRCUIT

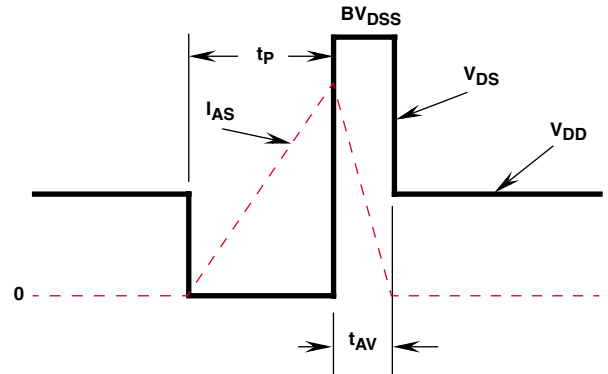

FIGURE 16. UNCLAMPED ENERGY WAVEFORMS

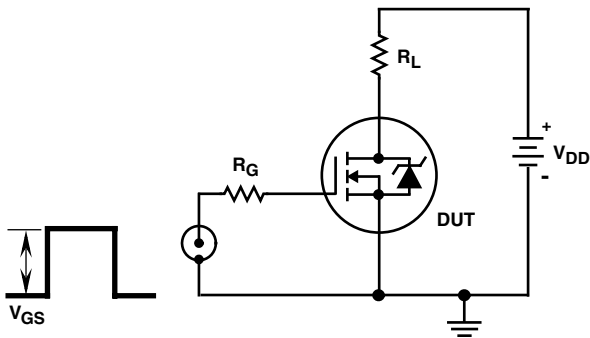

FIGURE 17. SWITCHING TIME TEST CIRCUIT

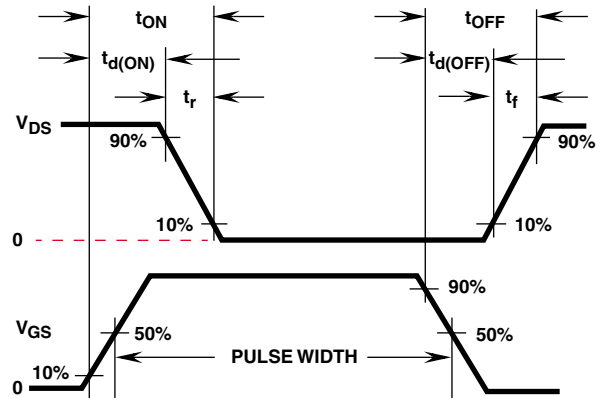

FIGURE 18. RESISTIVE SWITCHING WAVEFORMS

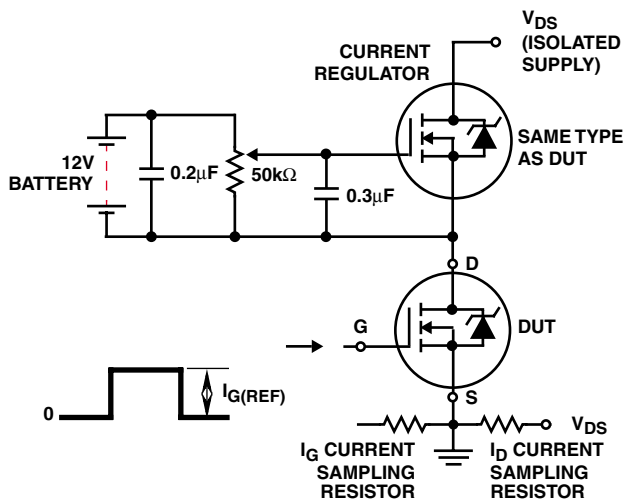

FIGURE 19. GATE CHARGE TEST CIRCUIT

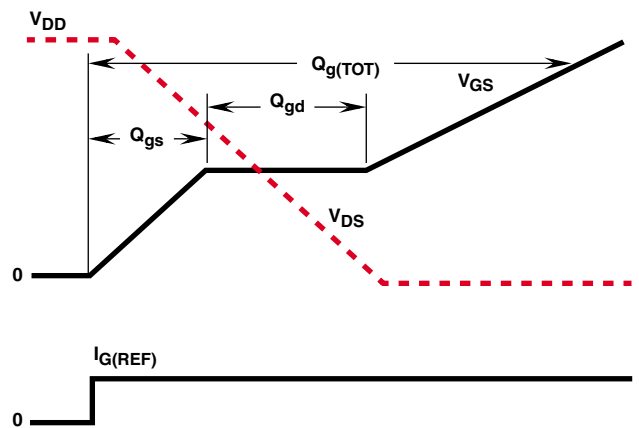

FIGURE 20. GATE CHARGE WAVEFORMS